

PICNIC トランシーバー 回路図

出力

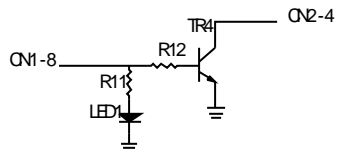

入力

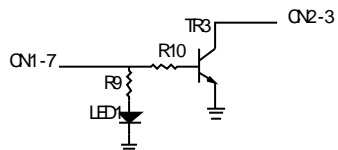
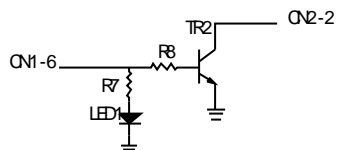
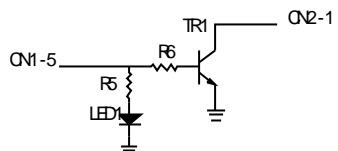
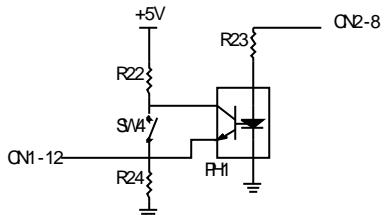
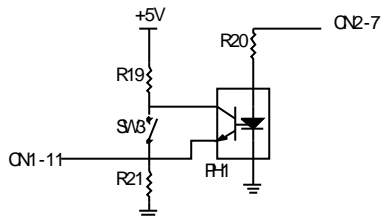
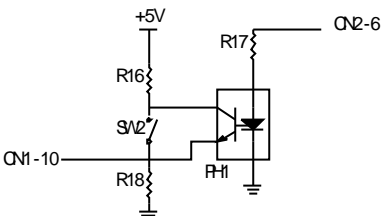
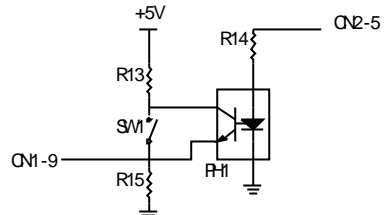

サーボ、サーバー・クライアント共通

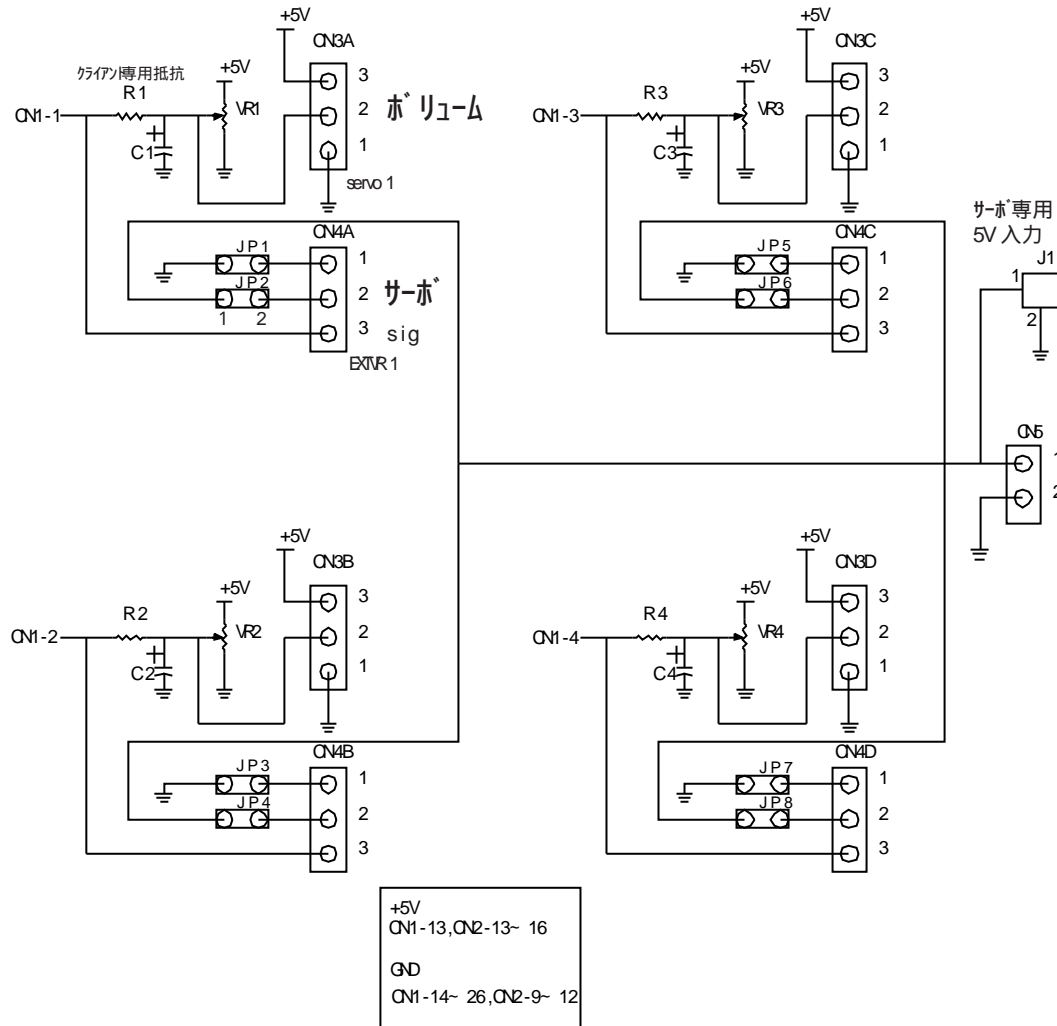

+5V
CN1-13, CN2-13~ 16
GND
CN1-14~ 26, CN2-9~ 12